

Rico Board Overview

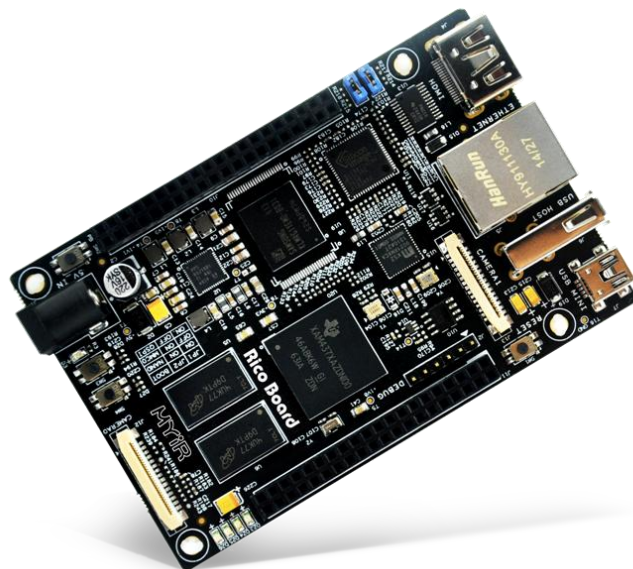

- ✓ Up to 1GHz TI AM437x Sitara ARM Cortex-A9 32-bit RISC Processor
- ✓ 512MB DDR3 SDRAM, 4GB eMMC Flash, 16MB QSPI Flash , 32KB EEPROM
- ✓ UARTs, USB Host/Device, Gigabit Ethernet, HDMI, Dual-Camera, LCD, TF, ...
- ✓ Supports Optional 4.3- or 7-inch LCD Module
- ✓ Supports Optional WiFi and Camera Modules
- ✓ Ready-to-Run Linux Single Board Computer



The Rico Board is an excellent high-performance Single Board Computer (SBC) using the newest TI's AM437x Sitara ARM Cortex-A9 based solution. This new generation solution has an increase in performance, as well as extensive reuse from the ARM Cortex-A8 offerings. It features up to 1GHz of processing power, 3D graphics acceleration for rich graphical user interfaces, PRU-ICSS for industrial protocols, improved Vector Floating Point unit and other peripherals and interfaces support like Quad-SPI, dual parallel cameras, two independent eight-channel ADCs, etc.

The AM437x processor family has four different pin-to-pin compatible AM437x device variations: the Sitara [AM4376](#), [AM4377](#), [AM4378](#) and [AM4379](#). They only have differences in options whether they have offered 3D graphics accelerator and their PRU can support for the EtherCAT slave protocol. Users can make selections according to their requirements.

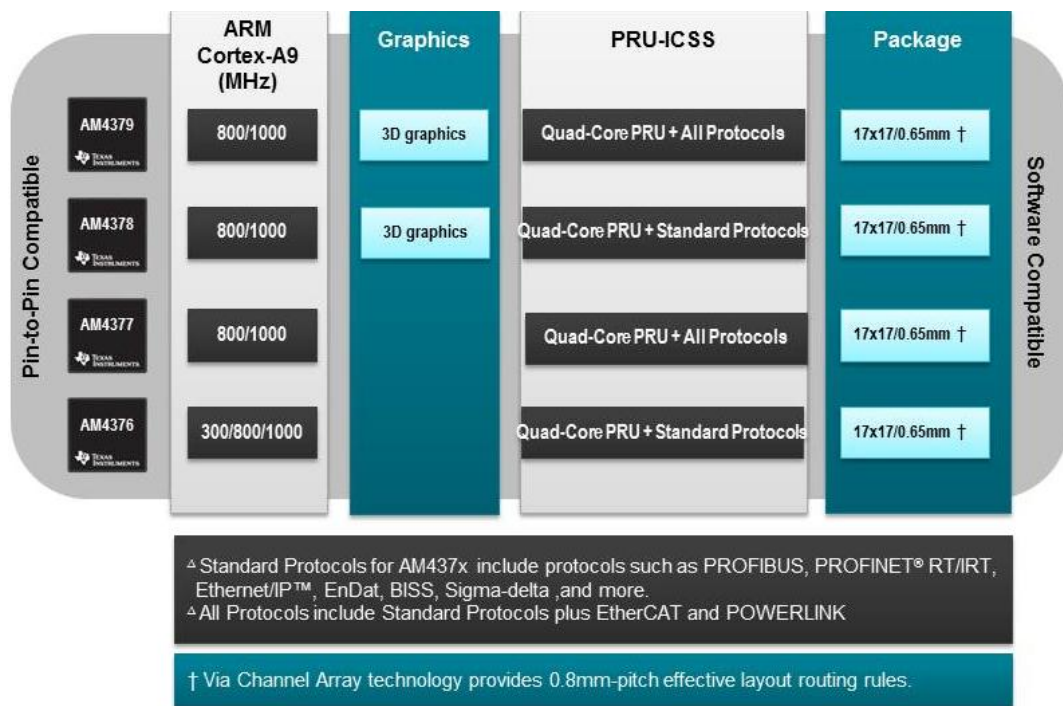
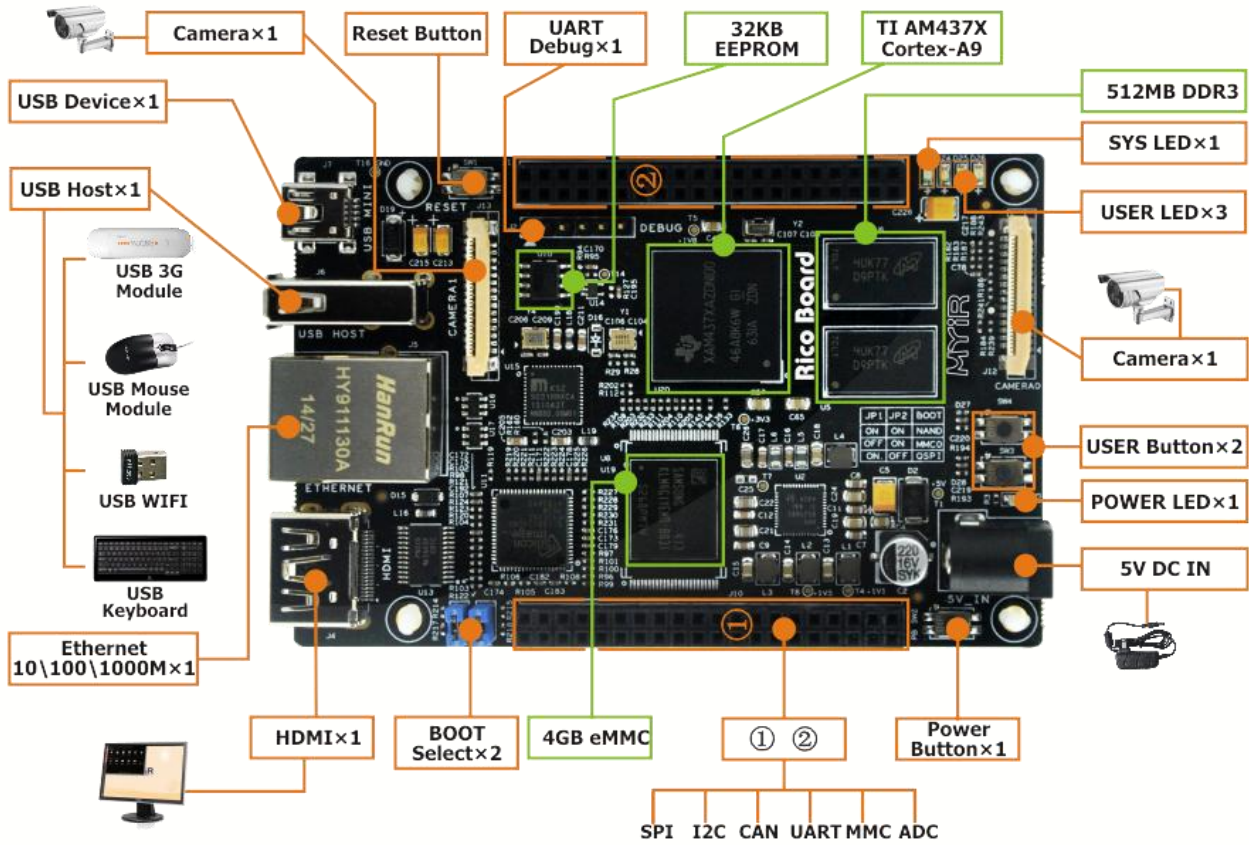

Figure 1-2 AM437x Devices

The **Rico Board** is equipped with **512MB DDR3, 4GB eMMC Flash, 16MB QSPI Flash and 32KB EEPROM**. Additionally, it has rich peripherals including a Debug serial port, USB 2.0 Host and Device ports, a **Gigabit Ethernet port**, TF card slot, **HDMI port, dual camera interfaces**, LCD interface, etc. Two 2.54mm pitch 40-pin expansion connectors allow the availability of more I/Os for peripheral signals like two SPI, two I2C, two CAN, four UARTs, one MMC and eight-channel ADC.

The **Rico Board** is capable of running Linux operating system and provided with **Linux 4.1.18** SDK of which the kernel and many drivers are in source code. MYIR also offers a complete Rico Board development kit that includes a Rico Board, necessary cable accessories, optional 4.3-inch or 7-inch LCD Module, optional WiFi and Camera modules as well as detailed documents to enable rapid development when customers getting the board out-of-the-box.

The **Rico Board** can be used for the evaluation module (EVM) for the AM437x processor family; it can also be used directly for your embedded products. Typical applications are industrial automation, Programmable Logic Controllers (PLCs), bar code scanners, portable data terminals, test and measurement, patient monitoring and human machine interface (HMI).



Rico Board Top-view

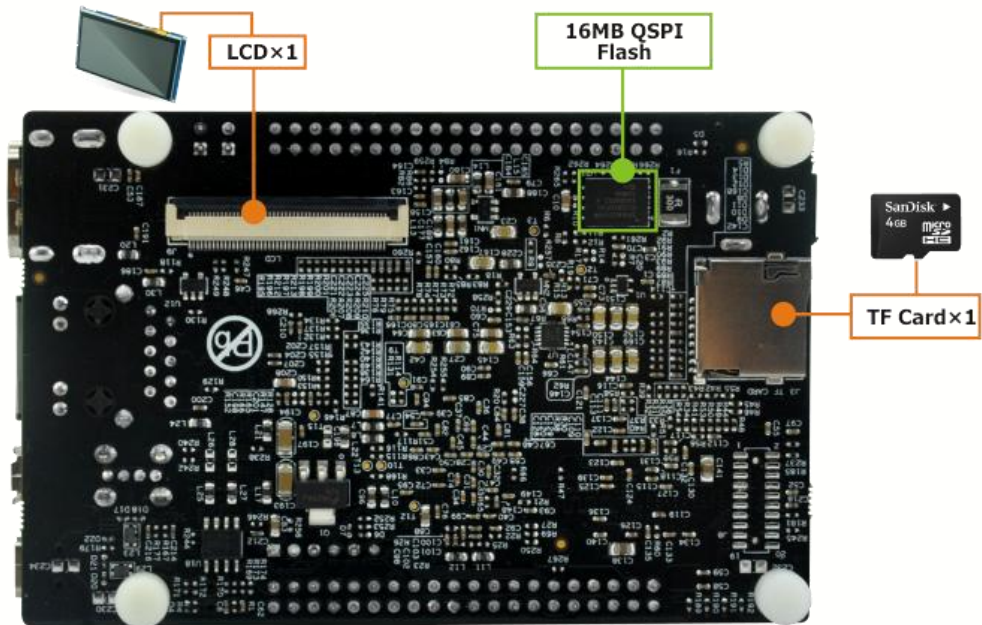

Rico Board Bottom-view



Hardware Features

The TI AM437x high-performance processors are based on the ARM Cortex-A9 core. Customers using this next generation solution will see an increase in performance, as well as extensive reuse from the ARM Cortex-A8 offerings.

Increasing performance and peripheral support

Sitara AM437x processors deliver the right balance of:

Performance

- Up to 1GHz of processing power
- 3D graphics accelerator
- On-chip quad-core PRU co-processor for real-time processing
- Improved vector floating-point unit

Interfaces

- LPDDR2/DDR3
- QSPI
- Display subsystem

Connectivity

- Two parallel camera ports
- Dual-port 1Gb Ethernet switch
- Two independent, eight-channel ADCs
- WiLink connectivity drivers
- Industrial protocols via PRU-ICSS

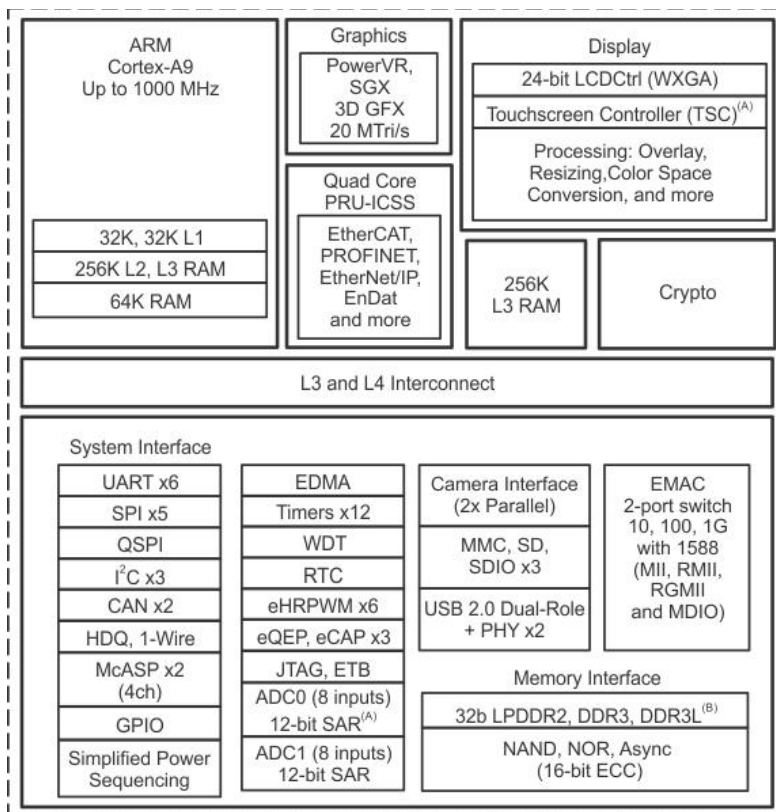

A. Use of TSC will limit available ADC0 inputs.

B. Max clock: LPDDR2 = 266 MHz; DDR3/DDR3L = 400 MHz

AM437x Function Block Diagram



The Rico Board is based on the TI AM437x processor and the hardware specification is as listed in following table:

Item	Features
Processor	Up to 1GHz TI AM437x Sitara ARM Cortex-A9 32-Bit RISC processor - POWERVR SGX Graphics Accelerator subsystem for 3D graphics acceleration to support display and gaming effects - Single-cycle vector floating point (VFP) - Dual camera and display processing subsystem - Cryptographic acceleration and secure boot - PRU-ICSS enables simultaneous industrial Ethernet protocols and motor feedback protocols - Support for 32 bit LPDDR2/DDR3/DDR3L - Low power: ~5mW deep sleep and < 0.1mW RTC-only - Simplified power sequence for flexible power designs
Memory	512MB DDR3 SDRAM (2 x 256MB, 32-bit), compatible with 256MB/1GB DDR3 SDRAM
Storage	4GB eMMC 256/512MB Nand Flash (reserved) 16MB QSPI Flash 32KB EEPROM TF card interface
Communications	1 x Debug serial port 1 x 10/100/1000M Ethernet 1 x Mini USB 2.0 Device port 1 x USB Host 2.0 port
Display	1 x HDMI interface 1 x LCD interface
Input and Output	1 x 20-pin JTAG interface 2 x 30-pin Camera Interfaces 4 x Buttons (1x Reset, 2 x User, 1 x Power) 5 x LEDs (3 x User LEDs, 1 x Power indicator, 1 RGB LED)
Others	2 x 2.54mm pitch 40-pin female expansion connectors brought out peripherals below: - 2 x SPI - 2 x I2C - 2 x CAN - 4 x UARTs - 1 x MMC - 8 x ADC
Dimensions	65mm x 100mm x 1.6mm (8-layer PCB design)
Power supply	USB power supply or DC 5V/2A
PMIC	Power Management IC (TPS65218)
Working Temp.	0~70 Celsius
OS	Linux 4.1.18

Rico Board Hardware Specification

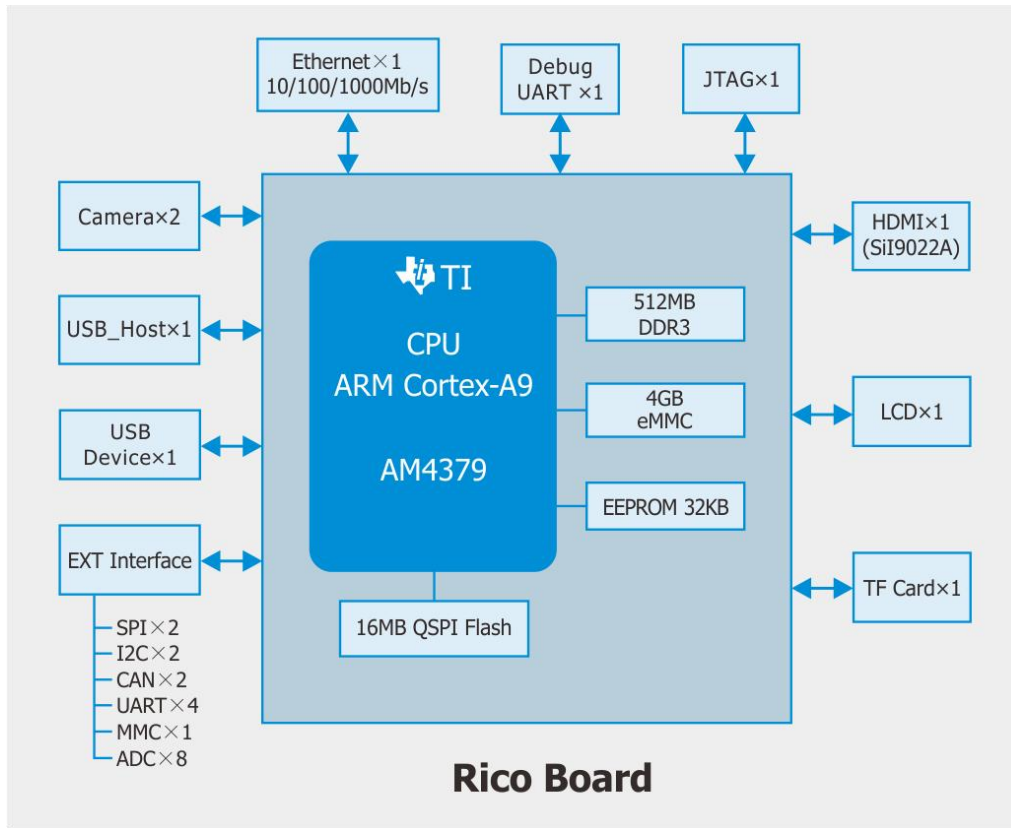

Rico Board Function Block Diagram

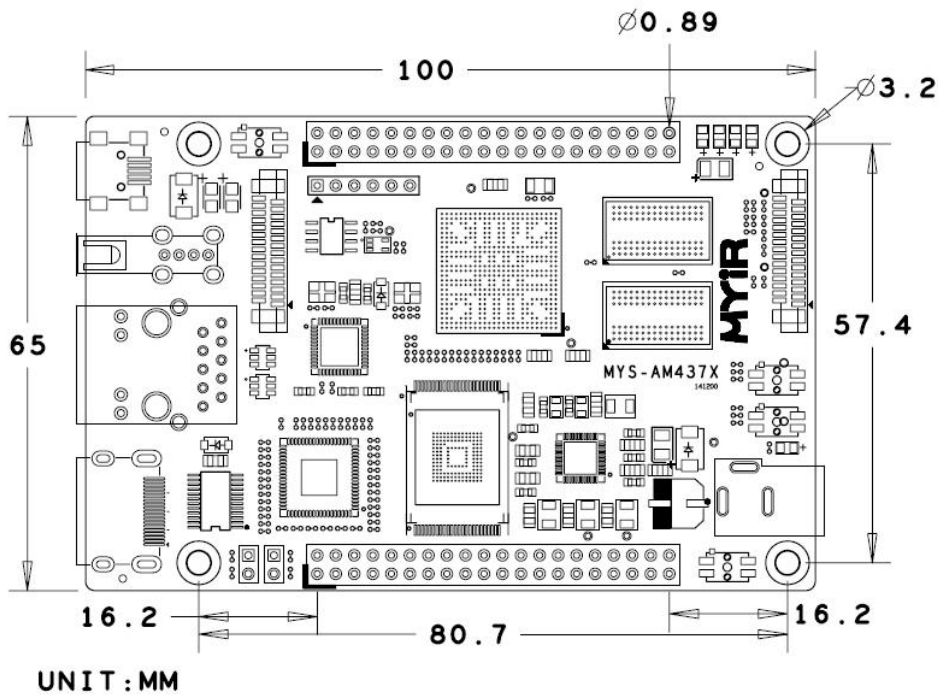

Rico Board Dimension Chart



Software Features

Item	Features	Description
Boot program	SPL	First boot program (source code)
	u-boot	Secondary boot program (source code)
Linux Kernel	Linux 4.1.18	Customized kernel for Rico Board (source code)
Drivers	USB Host	USB Host driver (source code)
	USB Device	USB Device driver (source code)
	Ethernet	Gigabit Ethernet driver (source code)
	MMC/SD/TF	MMC/SD/TF card driver (source code)
	NandFlash	NandFlash driver (source code)
	eMMC	eMMC driver (source code)
	LCD Controller	LCD driver (supports 7 inch LCD Module, source code)
	Touch	Touch driver (source code)
	HDMI	HDMI driver (source code)
	Button	Button driver (source code)
	UART	UART driver (source code)
	LED	LED driver (source code)
	GPIO	GPIO driver (source code)
	RTC	RTC driver (source code)
	Watchdog	Watchdog driver (source code)
Camera	Camera driver	
File System	Buildroot	Provide tar package and ubi image file
Demo	Audio, CAN, CAMERA, EEPROM, framebuffer, gpio, keypad, led, rtc, RS232. RS485	

Rico Board Software Features

Order Information

Item	Part No.	Packing List
Rico Board	MYS-4378-100-C-S	✓ One Rico Board
Rico Kit	MYS-4378-100-C	✓ One Rico Board ✓ One 1.5m cross Ethernet cable ✓ One 1.5m Mini USB2.0 cable ✓ One HDMI cable ✓ One 16GB TF card ✓ One 5V/2A Power adapter
MY-TFT043RV2 LCD Module	MY-TFT043RV2	4.3-inch LCD Module with resistive touch screen
MY-TFT070RV2 LCD Module	MY-TFT070RV2	7-inch LCD Module with resistive touch screen
MY-TFT070CV2 LCD Module	MY-TFT070CV2	7-inch LCD Module with capacitive touch screen
MY-WF003U WiFi Module	MY-WF003U	USB based WiFi Module
MY-CAM002U Camera Module	MY-CAM002U	USB Camera Module
MY-CAM011B Camera Module	MY-CAM011B	BUS Camera Module

MYIR Electronics Limited

Headquarter Address: Room 04, 6th Floor, Building No.2, Fada Road, Yunli Smart Park, Bantian, Longgang District, Shenzhen, Guangdong, China 518129

Factory Address: Room 201, Block C, Shengjianli Industrial Park, Dafu Industrial Zone, Guanlan, Longhua District, Shenzhen, 518110, China

Website: en.myir.cn

Email: sales@myir.cn

Tel: +86-755-22984836